

NO.S2DDY80LV0

2D Barcode Scanner User Manual

The following is general setup of this barcode scanner,
please contact local distributor for more technical support

Structure Chart:

Button: Enable/Disable to read 2D barcode.

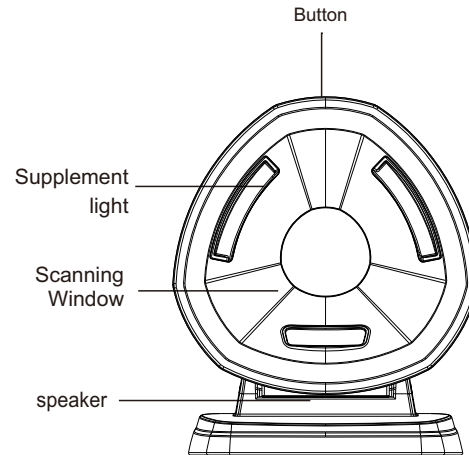

Features :

- (1) Compatible with Linux ,Android,Windows XP, 7,8,10 and Mac operating system
- (2) Support switch to 1D barcodes read mode ,avoid reading adjacent 2D barcodes
- (3) Easy to read laminated and screen barcodes such as mobile devices
- (4) Fast and accurate read common 1D & 2D barcodes
- (5) Ultra-wide scan window and Ultra-far read distance
- (6) Eye-safe red led light

Basic Configuration



Factory Default

Version

Suffix Setting



CR & LF



CR(default)



Tab

Interface Mode



USB-HID(default)



RS232



USB-COM

Interface Notes :

- (1) USB-HID Mode: Factory default mode ,automatically identify and install driver;
- (2) RS232 Mode:Require special customized RS232 cable and designated serial port APP(Default parameters :Baud Rate 9600 Data Bit:8bits Stop Bit :1bit Check Bit :None);
- (3) USB-COM ,Required to install special driver (Claim it from distributor).

Baud Rate



4800



9600(default)



57600



115200

Note:Baud Rate must be same between barcode scanner and serial port APP.Eg:Barcode Scanner default Baud Rate is 9600,the APP must choose same Baud Rate 9600

Keyboard language



USA(default)



French



German



Italian

Inverted Barcode Settings



Read normal barcode only(default)



Read normal & Inverted barcode

Buzzer



Low



High(default)

Symbology configuration



Enable All 1D Barcodes



Disable All 1D Barcodes



Enable All 2D Barcodes



Disable All 2D Barcodes

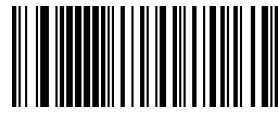

Enable UPC-A to EAN-13



Disable UPC-A to EAN-13 (default)



Enable UPC-E to UPC-A

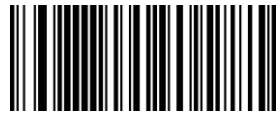

Disable UPC-E to UPC-A (default)



Enable EAN13 to ISBN



Disable EAN13 to ISBN (default)



Enable EAN13 to ISSN



Disable EAN13 to ISSN (default)

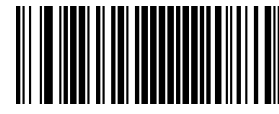

Enable UPC/EAN/JAN extra-code



Disable UPC/EAN/JAN extra-code

Reading Interval Settings



Reading interval of same barcode
300ms

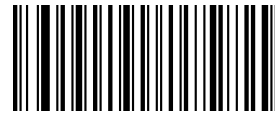

Reading interval of same barcode
500ms

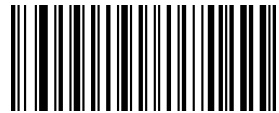

Reading interval of same barcode
750ms

Case Settings

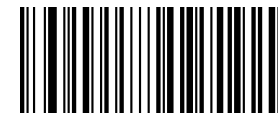

Case Inversion



All Uppercase

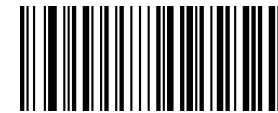

Keyboard Case Normal Output

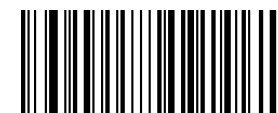

All Lowercase

Trouble shooting:

If the barcode scanner is not working properly, please try to check as follow instructions

- (1) Check the cable to make sure it is the original cable and connect to host properly
- (2) Check the barcodes required to read, it is possible not to read wrinkled, defaced, poor printed etc barcodes
- (3) Check the barcode type, make sure the barcode scanner support it and already enabled

For more info, please contact distributor for technical support

Cautions:

- (1) Reading window must be kept clean, the supplier is exempt from warranty liability for damage caused by improper maintenance and use
- (2) Avoid the reading window to be abraded or scratched by hard and rough objects
- (3) Avoid liquid spilling to the reading window
- (4) Do not stare into beam when the led light on